

TOLL-1L PACKAGE OUTLINE

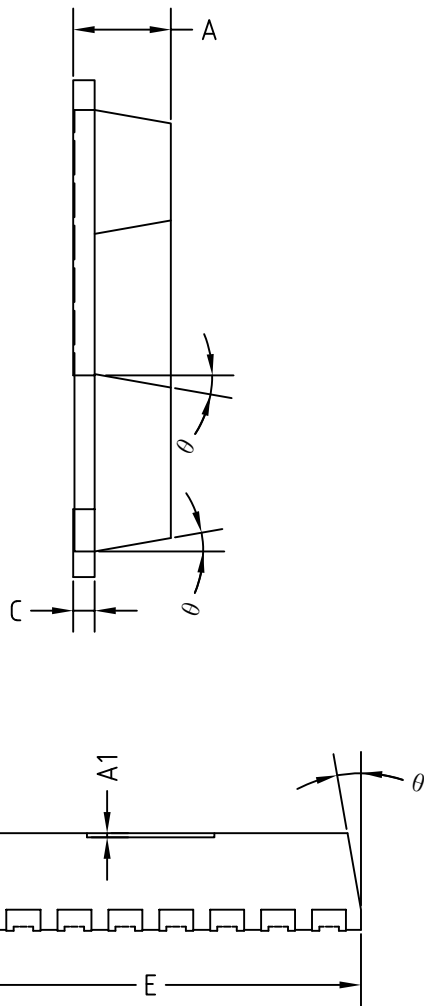
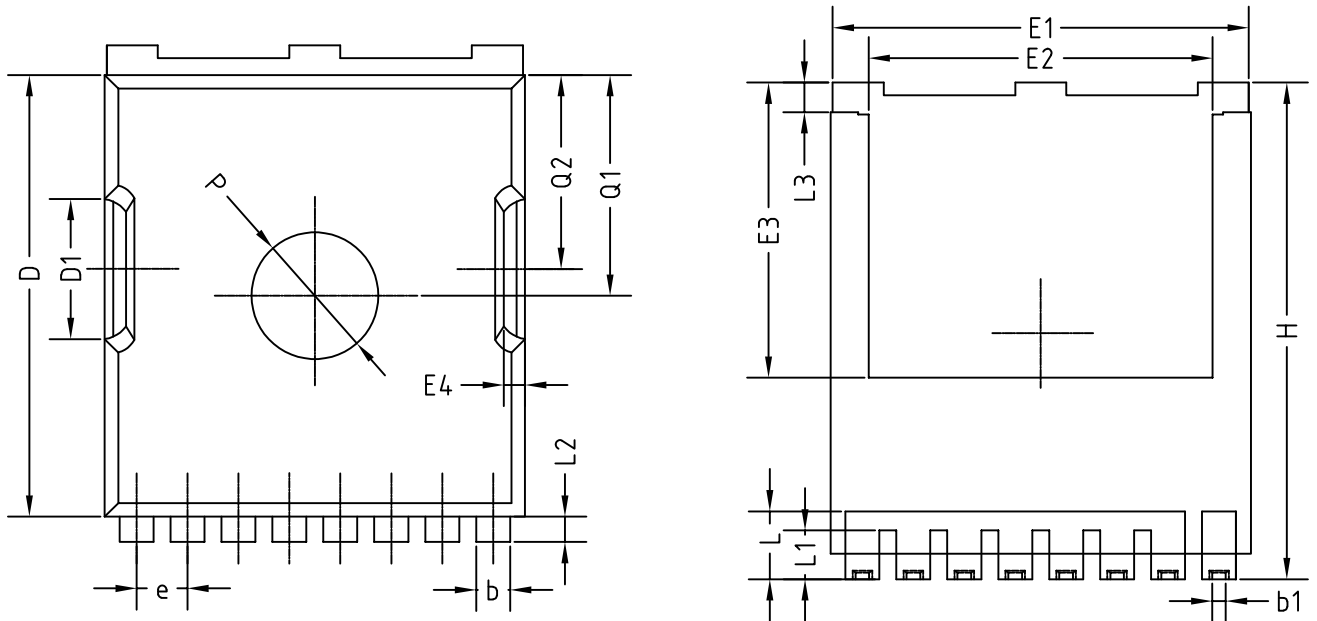

COMMON DIMENSIONS						
DIM	MILLIMETERS			INCHES		
	MIN	NOR	MAX	MIN	NOR	MAX
A	2.20	2.30	2.40	0.087	0.091	0.094
A1	0.05	0.10	0.20	0.00	0.004	0.008
b	0.65	0.80	0.85	0.026	0.031	0.033
b1	0.30	0.40	0.50	0.012	0.016	0.020
C	0.35	0.46	0.65	0.014	0.018	0.026
D	10.35	10.55	10.70	0.407	0.415	0.421
D1	3.15	3.30	3.45	0.124	0.130	0.136
E	9.80	9.90	10.00	0.386	0.390	0.394
E1	9.65	9.80	9.95	0.380	0.386	0.392
E2	7.90	8.10	8.30	0.311	0.319	0.327
E3	6.80	7.0	7.20	0.268	0.276	0.283
E4	0.30	0.50	0.75	0.012	0.02	0.03
e	1.15	1.20	1.25	0.045	0.047	0.049
L	1.35	1.60	1.85	0.053	0.063	0.073
L1	0.95	1.20	1.35	0.037	0.045	0.053
L2	0.40	0.60	0.80	0.016	0.024	0.031
L3	0.60	0.70	0.85	0.024	0.024	0.031
theta	7°	10°	12°	7°	10°	12°
P	2.90	3.00	3.10	0.114	0.118	0.122
Q	4.50	4.60	4.70	0.177	0.181	0.185
Q1	5.10	5.20	5.30	0.201	0.205	0.209
H	11.55	11.70	11.95	0.455	0.461	0.470

UNIT: mm

NOTE: 测量不包含毛刺、飞边。