

DESC1065E

10.0AMPS.SIC SCHOTTKY BARRIER DIODE

FEATURE

- . 650V Schottky Diode
- . Zero Reverse Recovery/Zero Forward Recovery
- . High Efficiency Operation
- . Extremely Fast Switching
- . Temperature Independent Switching Behavior

TYPICAL APPLICATIONS

- . Switch mode power supply
- . Power factor correction Solar Invertor
- . Solar inverter
- . Uninterruptible power supply

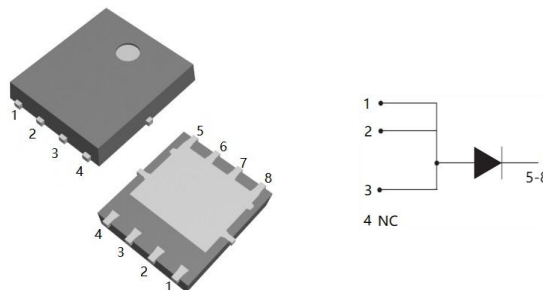
DFN5*6

MAXIMUM RATINGS ($T_C=25^\circ\text{C}$ unless otherwise noted)

Parameter	Symbol	DESC1065E	Units
Maximum Recurrent Peak Reverse Voltage	V_{RRM}	650	V
Maximum RMS Voltage	V_{RMS}	455	V
Maximum DC blocking Voltage	V_{DC}	650	V
Maximum Average Forward Rectified Current at $T_C = 150^\circ\text{C}$	$I_{F(AV)}$	10	A
Non-Repetitive Peak Forward Surge Current $T_c=25^\circ\text{C}, t_p=8.3 \text{ ms}, \text{ Half Sine Pulse}$	I_{FSM}	86	A
Total power dissipation $T_c=25^\circ\text{C}$	P_D	62.5	W
Operation Junction Temperature and Storage Temperature	T_J, T_{STG}	-55 to +175	$^\circ\text{C}$

ELECTRICAL CHARACTERISTICS ($T_C=25^\circ\text{C}$ unless otherwise noted)

Parameter	Symbol	Typ	Max	Units	
Forward voltage	V_F	$I_F=10\text{A}, T_j=25^\circ\text{C}$	1.27	1.5	V
		$I_F=10\text{A}, T_j=175^\circ\text{C}$	1.38	1.6	
Reverse current	I_R	$V_R=650\text{V}, T_j=25^\circ\text{C}$	6	50	μA
		$V_R=650\text{V}, T_j=175^\circ\text{C}$	25	200	
Total capacitive charge	Q_c	25	---	nC	
Total capacitance	C	$V_R=0\text{V}, T_j=25^\circ\text{C}, f=1\text{MHZ}$	640	---	pF
		$V_R=200\text{V}, T_j=25^\circ\text{C}, f=1\text{MHZ}$	66	---	
		$V_R=400\text{V}, T_j=25^\circ\text{C}, f=1\text{MHZ}$	48	---	

THERMAL CHARACTERISTICS ($T_C=25^\circ\text{C}$ unless otherwise noted)

Parameter	Symbol	Typ	Max	Units
Typical Thermal Resistance Junction to Case	$R_{(JC)}$	2.4	----	$^\circ\text{C}/\text{W}$

RATING AND CHARACTERISTIC CURVES

FIG.1-FORWARD CHARACTERISTICS

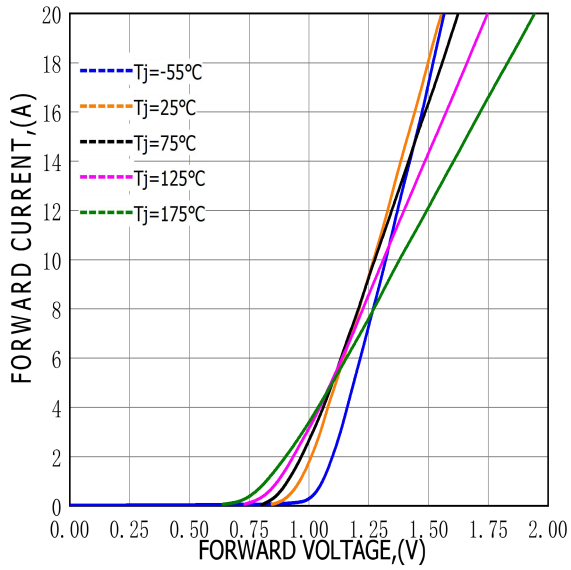

FIG.2-REVERSE CHARACTERISTICS

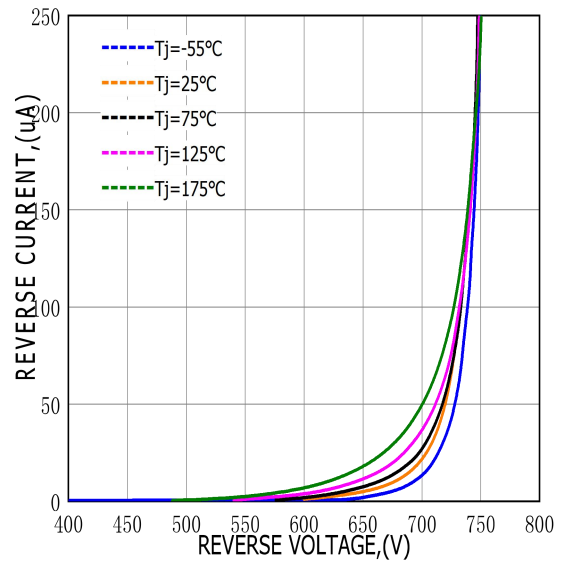

FIG.3-TOTAL CAPACITANCE CHARGE VS REVERSE VOLTAGE

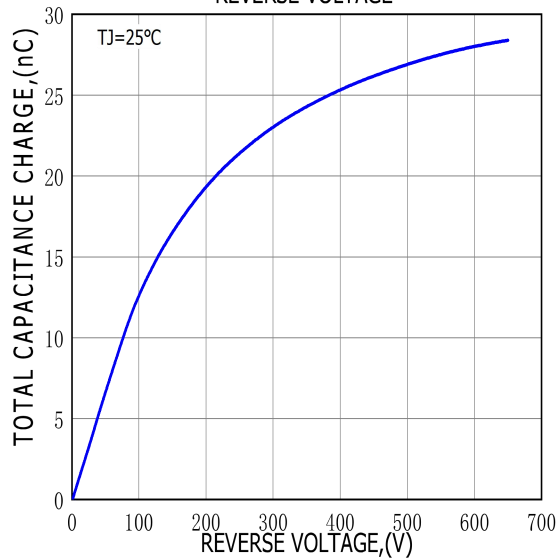
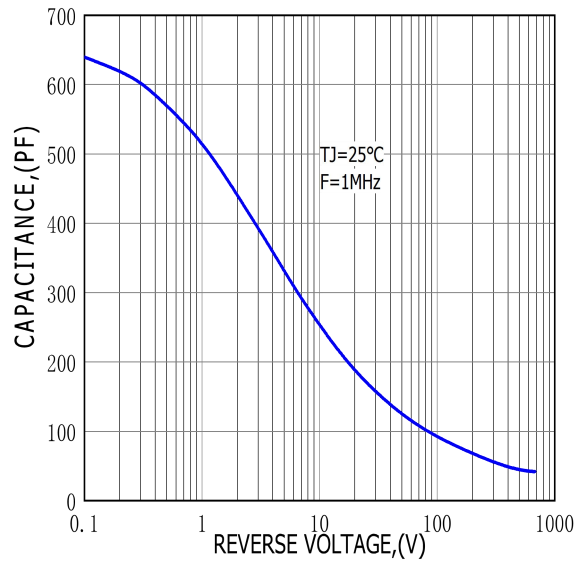
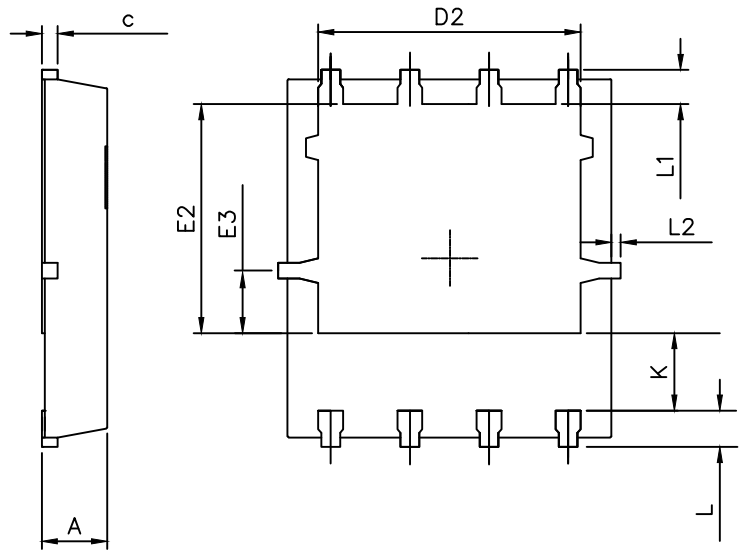
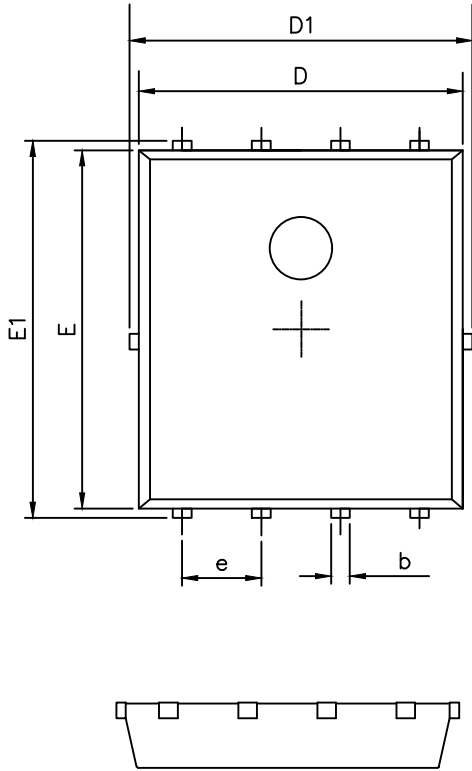

FIG.4-CAPACITANCE VS REVERSE VOLTAGE



DFN5x6 PACKAGE OUTLINE



RECOMMENDED LAND PATTERN

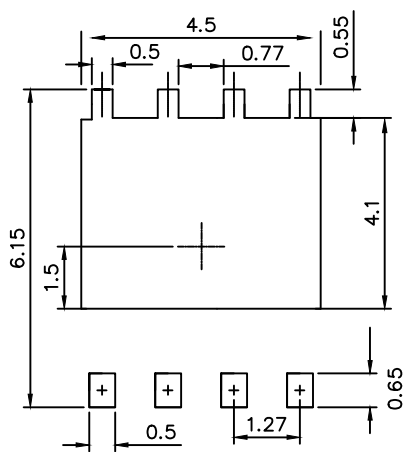

UNIT: mm

	MIN	NOM	MAX
A	0.90	1.00	1.10
b	0.25	0.35	0.50
c	0.10	0.20	0.30
D	4.80	5.00	5.30
D1	4.90	5.10	5.50
D2	3.92	4.02	4.20
E	5.65	5.75	5.85
E1	5.90	6.05	6.20
E2	3.325	3.525	3.775
E3	0.80	0.90	1.00
e		1.27	
L	0.40	0.55	0.70
L1		0.65	
L2	0.00		0.15
K	1.00	1.30	1.50